

Corporate Brochure

We are ISO 9001:2008 certified company, SSi Registered Company  
Importer, Exporter, Stokists & Suppliers of ferrous and non-ferrous raw materials.

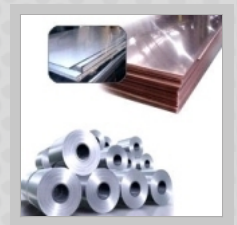

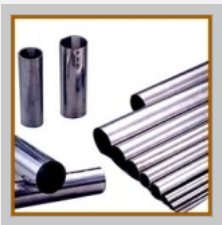

- Profile -

Established in the year 2011, We, “Heubach International”, are an ISO 9001:2008 certified company engaged in importing, supplying and exporting wide array of **Pipe Fittings** and **Ferrous & Non Ferrous Material**. We are the best exporter in the marketplace. These products are widely used for process control and instrumentation connections between pipe size and tube size. We offer our products in various shapes and sizes as per the diverse requirements of the clients. Moreover, with our streamlined business operations, we have We have achieved **Indian Achievers' Award** in the year 2011 as one of the fastest emerging company.

In order to deliver a flawless range of product, our products are sourced from the trusted vendors of the market. We have employed quality auditors to check the quality of the products at the time of procurement so as to ensure the flawlessness of the end product. The products are being stored at our spacious warehouse so as to meet the bulk requirement of the clients. Our warehouse professionals are responsible to keep the warehouse clean. Transportation facility is well connected to our warehouse for the quick and easy transit of the consignments. We have gained client's appreciation across the Indian subcontinent due to our ethical business practices, easy payment options and transparency in dealings.

Our mentor, 'Mr. Mahendra Jain', is a man of vast domain knowledge, who is responsible for the growth of the organization. He has always motivated us to work towards achieving the client's satisfaction.



### Stainless Steel Product:

Backed by sound industry experience, we are able to offer an excellent range of Stainless Steel products to our valuable clients. Our expertise allows us to offer these products in various sizes, thicknesses, lengths and grades as per the clients' requirements. These products are widely acknowledged by clients due to their durability, corrosion resistance and high tensile strength.

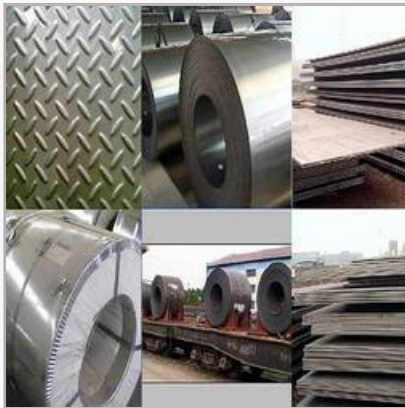

Sheets And Plates



Bar Rod & Wire



Buttweld Fitting



Forged Fitting



## Carbon Steel Products:

Our carbon steel products are IBR test certified (form III-D). Laboratory test certificate from govt. approved lab & under third party inspection with excise gate pass to avail modvat benefit. Our range includes carbon steel tubes, carbon steel flanges, carbon steel forged fittings and carbon steel butt weld fittings.

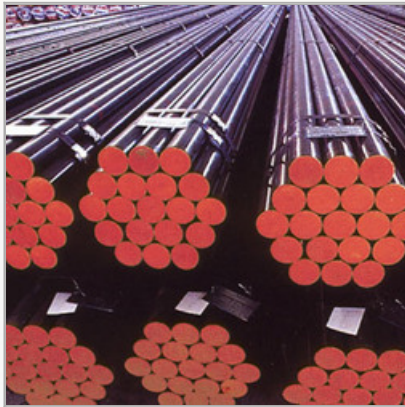

Carbon Steel Pipes



Carbon Steel Flanges



Carbon Steel Tubes



Carbon Steel Forged Fittings



## Steel Pipes:

We are engaged in export and supply of wide range of steel pipes i.e, corrugated steel pipes, seamless steel pipes, ERW steel Pipes, Welded steel pipes etc. in wide range of shapes and sizes.

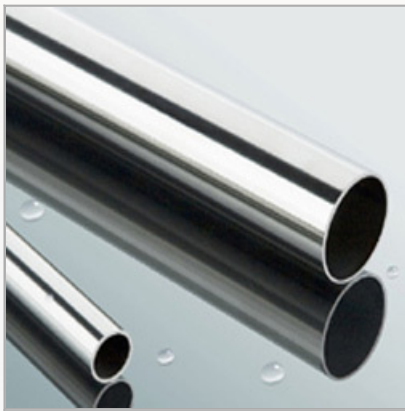

Seamless Steel Pipes



ERW Steel Pipes

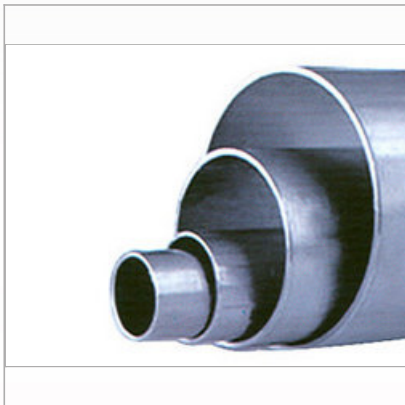

Welded Steel Pipes



Pipes And Tubes



## Steel Tubes:

We are engaged in manufacturing of wide range of steel seamless tubes, welded steel tubes & CDW tubes for different industrail applications.



Seamless Steel Tubes



Welded Steel Tubes

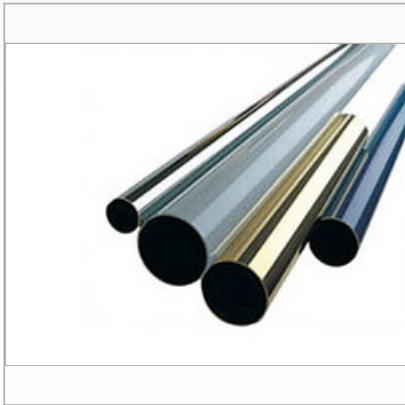

CDW Tubes

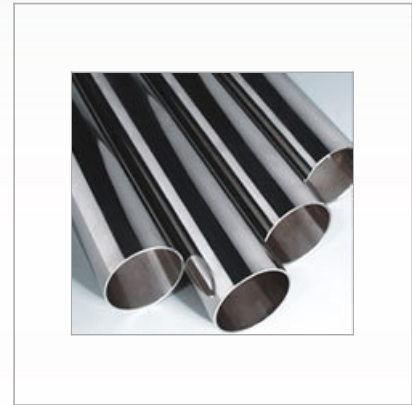

Stainless Steel Tubes



## Duplex And SuperDuplex Steel Products:

We offer a wide range of duplex steel products, which are manufactured in diverse diameters and length parameters. Using high temperature alloys to manufacture our round bars, we make sure that our range can be applied in various industrial applications. Our range includes duplex steel pipes, duplex steel tubes, industrial steel pipes, industrial steel tubes etc.



Duplex & Super-Duplex  
Flanges

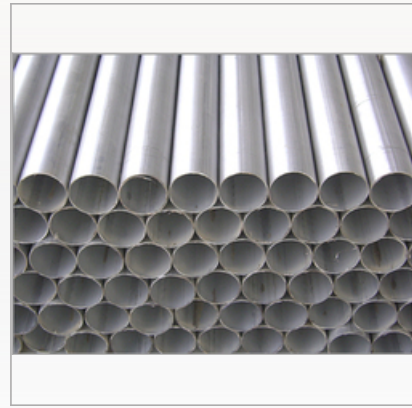

Duplex & Super-Duplex  
Steel Pipes



Duplex & Super-Duplex I  
Tubes



Duplex & Super-Duplex  
Buttweld Fittings



## Metal Bars:

We are catering an exclusive range of metal bars, stainless steel bars, steel round bars, stainless steel round bars which is of superior quality. The gamut catered by us is highly durable, reliable and can be customized as per the requirements of the clients.



**Stainless Steel Bars**



**Alloy Steel Round Bars**



**Duplex Steel Round Bars**





**Special Steels:**

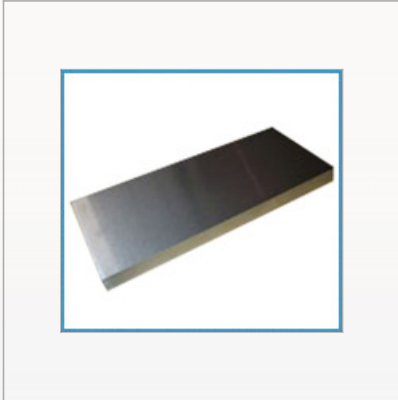

**Nickel Plates**

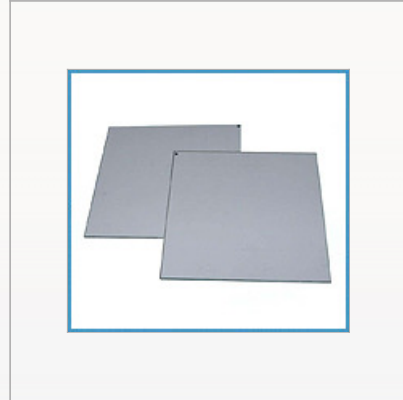

**Nickel Sheets**

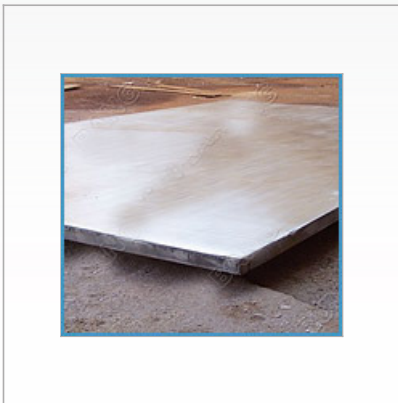

**Titanium**



**Alloy 20**



### Forged Fittings:

We have expertise to develop forged fittings like forged pipe fittings, socket weld pipe fittings, steel tees, steel elbows in accordance with customers' drawings and specifications.



Steel Tees



Steel Elbows



Steel Couplings



Steel Cap



## Industrial Flanges:

We offer a large variety of industrial, made of superior quality metals and are high performing. These industrial flanges are long lasting, shock proof and are designed with utmost precision.



Weld Neck Flanges



Reducing Flanges



Plate Flanges



Screwed Flanges



## Industrial Fasteners:

We are engaged in offering industrial fasteners and industrial fasteners fittings that are developed from quality raw material in different sizes. We provide our range of industrial fasteners in various specifications and can be customized as per the specification detailed by the clients.

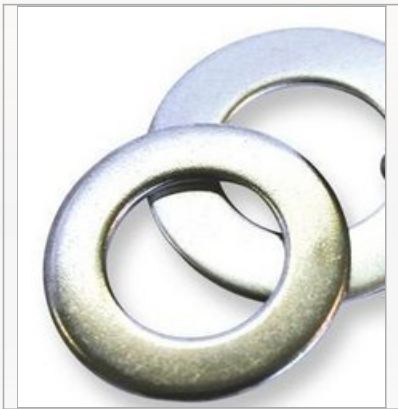

**Industrial Washers**



**Industrial Nuts**



**Industrial Bolts**

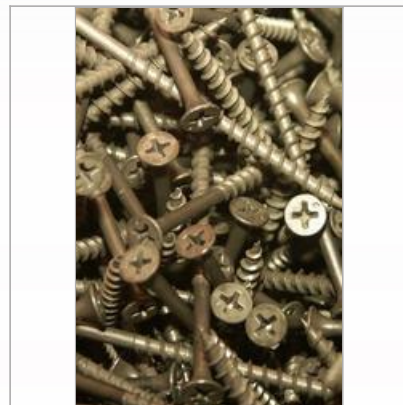

**Industrial Screws**



## Monel Products:

We offer monel products that includes monel pipes, monel tubes, monel flanges, monel fittings, monel buttweld fittings, monel forged fittings, monel rods, fasteners and other monel fittings. These are available in grades like Monel 400 (UNS No. N04400), Monel 500 (UNS No. N05500) etc.



**Monel Flanges**



**Monel Tubes**



**Monel Round Bar**



**Monel Pipes**



## Hastelloy Products:

Hastelloy is non-ferrous metal, we offer many hastelloy products used in petrochemicals plants, oil refineries, fertilizers plants, sugar mills, chemical plants, pharmaceuticals, textile machinery, industrial machinery, power industry & cement industry.

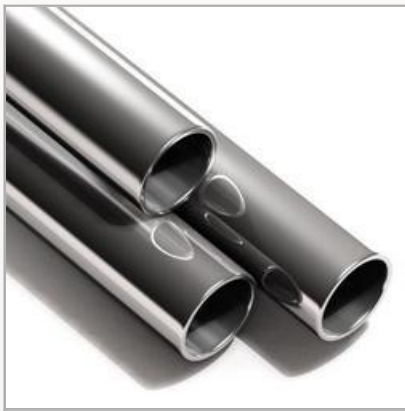

Hastelloy Tubes



Hastelloy Flanges



Hastelloy Pipes

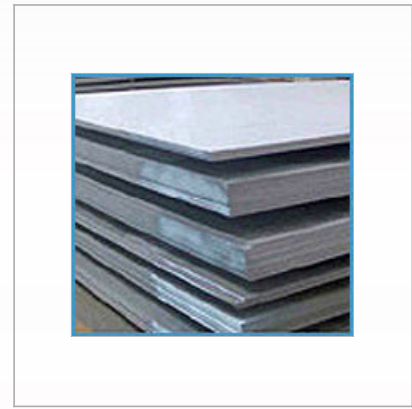

Hastelloy Plates and Sheets



## Nickel Alloy Products:

We offer wide range of nickel products in various forms like nickel pipes and tubes, nickel flanges, nickel sheet and plates, nickel fasteners, nickel rods etc in the following high quality grades.

**Grade** - Nickel 200 (UNS No. N02200), Nickel 201 (UNS No. N02201)



**Nickel Alloy Tubes**



**Nickel Alloy Butt Weld Fittings**



**Nickel Round Bar**



**Nickel Alloy Fasteners**



## Titanium Products:

We offer titanium products that includes titanium fasteners, titanium pipes, titanium tubes, titanium flanges, titanium butt weld fittings and titanium forged fittings.



**Titanium Fasteners**



**Titanium Tubes**



**Titanium Pipes**



**Titanium Flanges**





### Copper Alloy Products:

We are counted among the leading suppliers and distributors of copper alloy in the market. Our products are corrosion resistant, water repellent and are thermostatically approved. We have a customer-centric approach and satisfy our customers in all respects. Copper alloy products offer wide application in electric motors, backing plate's castings and welding applications.



Copper Pipe Fittings



Copper Pipes



Copper Tubes



Copper Strips



## Refractory Anchor:

The refractory anchor fasteners are a mark of complete industrial growth and a reasonable approach towards the completion of a good industrial approach in manufacturing. We insure and promise a quality based groove cutting on our machine that makes sure that we get a perfect fitting on the assembly. We offer very reasonable prices



Steel Refractory Anchor

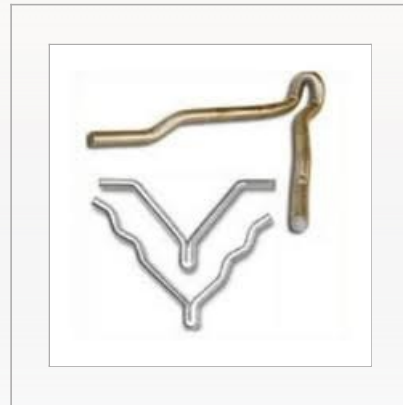

Metal Refractory Anchors

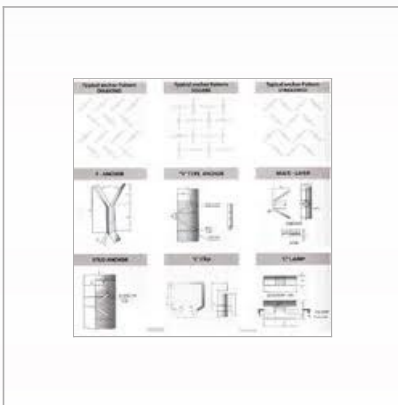

Stainless Steel Clamps



Refractory Anchor & Fastner



## Olets Range:

We provide a qualitative assortment of **Olets** that are in great demand in the domestic as well as international market. These Olets are offered in several sizes, forms and dimensions to cater the various industrial requirements. These products are manufactured using high quality raw material.



Olets



Sockolet Olets



Insert Olets



Elbowlet Olets



## Steel Flanges:

We offer different types of steel flanges, which are made of materials like stainless steel, carbon steel, alloy steel, duplex steel, etc. Our steel flanges are available in different pressure ratings, dimensions and other technical specifications. Conforming to ASTM and ASME specifications, these ss flanges are suitable for a hosts of industrial hydraulic-pneumatic applications.



**Metal Flanges**



**Stainless Steel Flanges**



**Carbon Steel Flanges**



**Nickel Alloy Flanges**



**Threaded Flanges:**

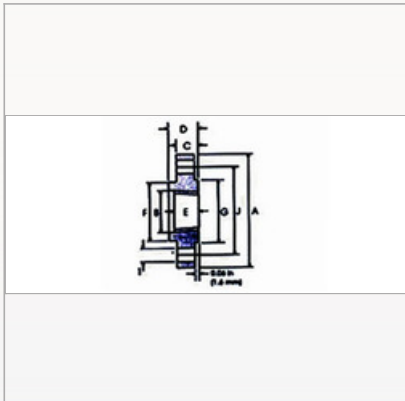

ANSI B 16.5 Class 150 lb

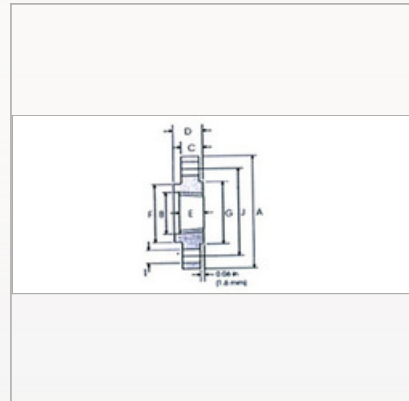

ANSI B 16.5 Class 300 lb

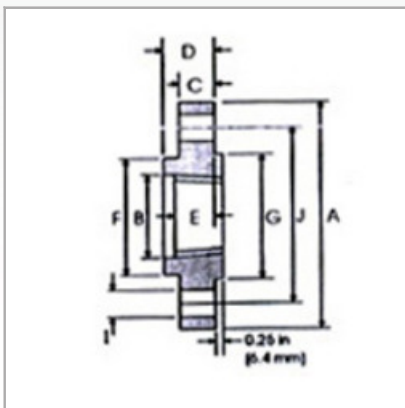

ANSI B 16.5 Class 2500 lb  
Weld Neck Flanges

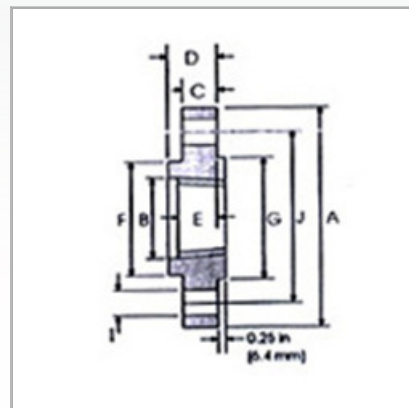

ANSI B 16.5 Class 900 lb  
Weld Neck Flanges



**Weld Neck Flanges:**

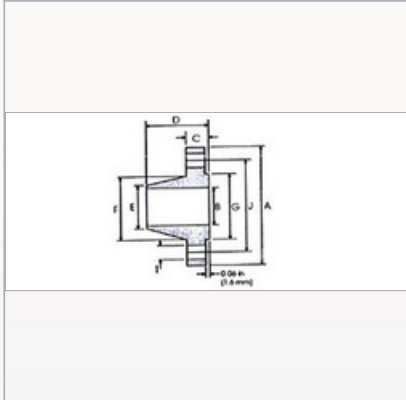

**Weld Neck Flanges**

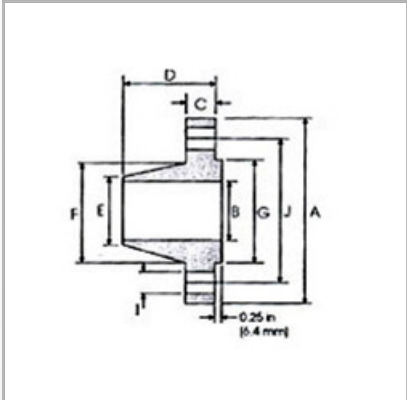

**ANSI B 16.5 Class 600 lb  
Weld Neck Flange**

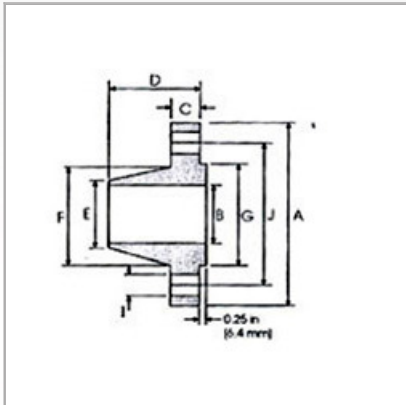

**ANSI B 16.5 Class 900 lb  
Weld Neck Flanges**

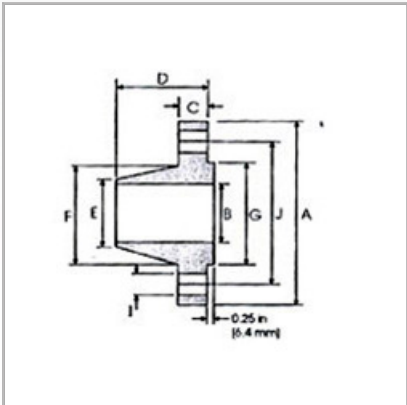

**ANSI B 16.5 Class 1500 lb**



- Company Factsheet -

<b>Year of Establishment</b>	2011
<b>Nature of Business</b>	<ul style="list-style-type: none"><li>▸ Supplier</li><li>▸ Distributor</li><li>▸ Exporter</li><li>▸ Wholesaler</li><li>▸ Trader</li></ul>
<b>Total Number of Employees</b>	Upto 10 People
<b>Major Markets</b>	<ul style="list-style-type: none"><li>▸ Australia/NZ</li><li>▸ Indian Subcontinent</li><li>▸ Caribbean</li><li>▸ East/Middle Africa</li><li>▸ North Africa</li><li>▸ South/West Africa</li><li>▸ East Europe</li><li>▸ East Asia</li><li>▸ Central America</li><li>▸ North Europe</li><li>▸ Middle East</li><li>▸ South America</li><li>▸ South/West Europe</li><li>▸ South East Asia</li><li>▸ North America</li></ul>



- Contact Us -

Contact Details:

**Heubach International**

Mr. Mahendra Jain

No. 21, Manipar House, 1st Floor, 1st Parsiwada Lane, Behind,  
Alankar Cinema

Mumbai, Maharashtra - 400 004, India

**Website:** [www.indiamart.com/heubach-international](http://www.indiamart.com/heubach-international)